



Read this manual carefully for the safe use of this unit.

# Ceramosonic S

Ceramosonic Condenser  
Ultrasonic condensing unit for porcelain build-up

## Directions For Use

CE 2006/95/EC  
2004/108/EC

MET LISTED  
MET<sup>®</sup> us  
UL61010-1  
CSA C22.2 No.61010-1  
E112695

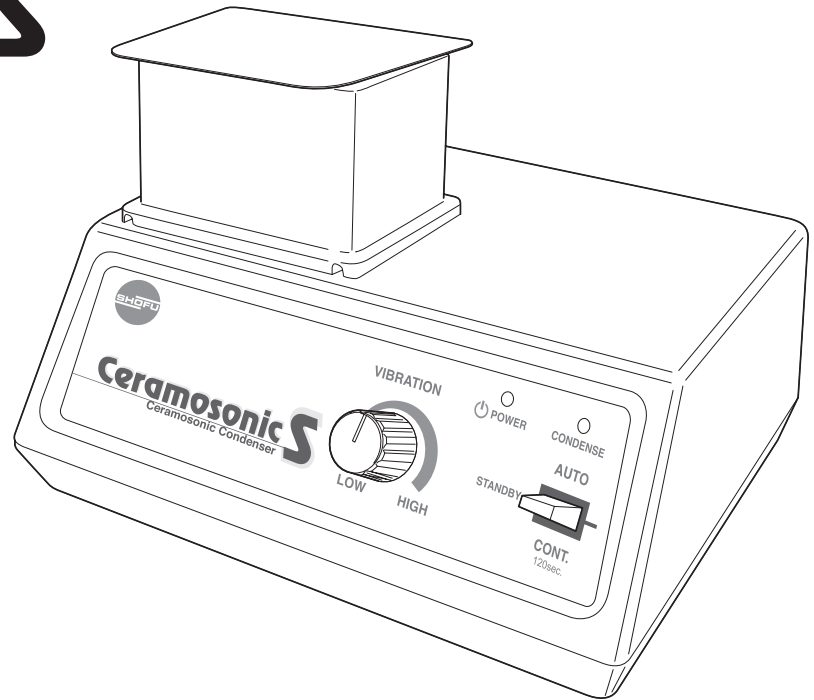

**SHOFU INC.**

## Introduction

Thank you for purchasing “CERAMOSONIC S”, ultrasonic condenser for porcelain build-up. This direction for use provides all the necessary operating information that you might require, including daily care and cautions. Please read this manual carefully prior to use to provide you with years of trouble-free operation and excellent performance. Keep this manual at hand for your future reference.

## Notes

- No part of this document may be copied or reproduced in any form by any means.
- Some information in this document might become inconsistent with the product due to product improvement.
- The information in this document is subject to change without prior notice.
- All relevant issues have been considered in the preparation of this document. However, should you notice an omission or any questionable item in this document, please feel free to notify SHOFU.
- In case of missing pages or disorder, please contact our local dealer for replacement.
- We deal with troubles of the main unit and its system within the coverage of warranty. However, we do not assume any responsibility if the operating instructions have not been followed resulting in failure of the unit.

## Contents

Introduction

Notes

Features .....	1
Intended use .....	1
1. Safety information .....	2 - 3
2. Part names and functions .....	4
3. Directions for use .....	5 - 7
4. Display .....	7
5. Operation .....	8 - 9
6. Maintenance / Check .....	10 - 11
7. EU Declaration of Conformity .....	11
8. Troubleshooting .....	12
9. Specification .....	13
10. Product configuration .....	13
11. Warranty.....	14

## ***Features***

### **1. Easy and reliable porcelain condensation by ultrasonic wave**

Just touching the vibrating platform with a pair of tweezers produces easy and reliable porcelain condensation. Micro-vibration by ultrasonic wave condenses porcelain more densely without ruining porcelain build-up.

### **2. Easy starting with the touch sensor**

Condensation starts easily by touching the vibrating platform with a pair of tweezers.

### **3. Less firing shrinkage with excellent adhesion**

Excellent condensation by ultrasonic wave reduces firing shrinkage. Opaque porcelain can be perfectly condensed on the entire surface of the metal, which enhances adhesion and can mask the metal color with a thin Opaque layer.

### **4. Optimal for all ceramics porcelain**

In case of all ceramics porcelain, which has low thermal conductivity, this reliable condenser minimizes firing shrinkage.

## ***Intended use***

Condensation for porcelain fused to metal and all ceramics porcelain

# 1. Safety information

Understand the following items to use the product safely.

## Descriptions of warnings and cautions

This manual provides safety information using the following symbols to prevent accidents resulting in injury or death and destruction of equipment. Understand the meanings of these labels to operate the equipment safely.



### WARNING

Warning indicates a potentially hazardous situation which, if not avoided, could result in death or serious injury.



### CAUTION

Caution indicates a potentially hazardous situation which, if not avoided, may result in minor or moderate injury or in property damage.

## Other notes and signs

Other notes and signs are used in this document are shown below.

### Note

Indicates that potential malfunctions may occur if you ignore the description.

## Installation and Connection



### WARNING

- Use ground terminal outlet and make sure grounding. In case of using ground adaptor, the cable must be grounded. Should the electricity leaks in the main unit, it might cause an electric shock or fire.
- Keep away from sources of ignition. This may cause fire or explosion.
- Unplug the power plug before connecting or disconnecting the power cord to the main unit. When connecting the power cord to the main unit, make sure the plug is inserted securely. Failure to do so may result in an electric shock.
- Switch off the unit after use. Unplug the power outlet when not in use for a long time. Insulation degradation may cause an electric shock or fire.



### CAUTION

- Never use with any voltage other than the voltage indicated, for AC cord 125 type (100-120V) and AC cord 250 type (220-240V), 50/60Hz or more. This may result in fire or an electric shock.

## ***Operation***

### **WARNING**

- Never use the unit near a person having a pacemaker. This may cause negative effects on the pacemaker.
- Never touch the power plug with wet hands. This may result in an electric shock.
- Never expose the unit to any liquid. Use extra caution for power plug. This may result in an electric shock or fire.
- Never insert metal or anything into the unit with hands. This may result in an electric shock, over heating or causing a fire.
- Switch off the unit after use. Unplug the power outlet when not in use for a long time. Insulation degradation may cause an electric shock or fire.

### **CAUTION**

- Unplug the power cord by grasping the power plug. Insulation degradation may cause injury, burns or fire.
- Never damage / reprocess or use unnecessary force on the power cord. Never place any heavy objects on the power cord. A damaged power cord may cause an electric shock and fire.

### **CAUTION**

- Check any damage on the main unit and accessories prior to use. Failure to do so may cause injuries or burns.
- Do not touch the vibrating platform with hands. Heat from the unit may cause injuries or burns.
- Never apply unnecessary strong force nor bend the vibrating platform. This may cause an unusual sound or result in failure of full performance.
- Never use the unit for any purposes other than specifically outlined in this direction for use.

## ***Maintenance / Check***

### **WARNING**

- Never disassemble the equipment. This may result in an electric shock. Should the equipment have a problem, do not disassemble or touch inside and ask for inspection and repair by an authorized SHOFU representative.

## 2. Part names and functions

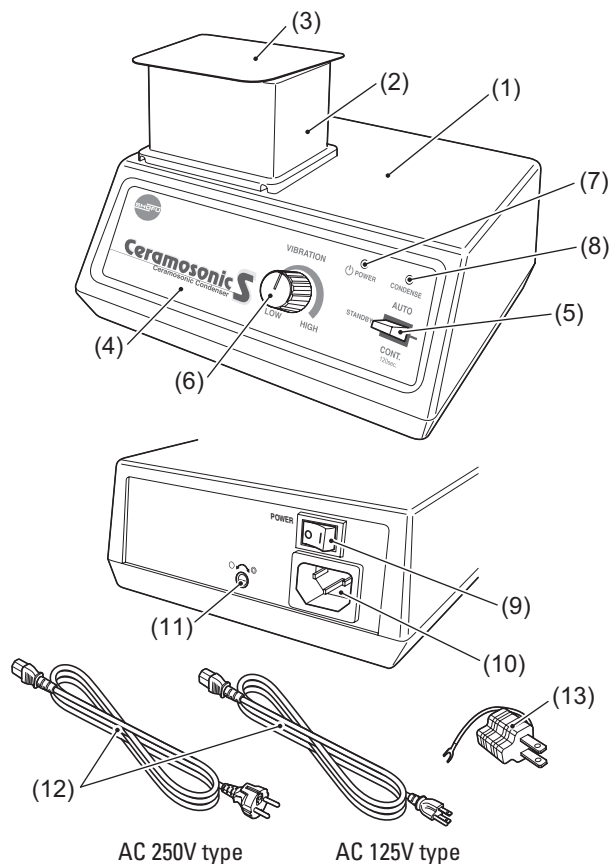

- 1 Main unit
- 2 Vibrator protect case
- 3 Vibrating platform
- 4 Front panel
- 5 Mode switch  
 AUTO  
 STANDBY  
 CONT. 120 sec.
- 6 VIBRATION controller  
 HIGH  
 LOW
- 7 POWER  
 \*Blinks when malfunctions
- 8 CONDENSE
- 9 POWER  
 ○ OFF  
 | ON
- 10 Power cord inlet
- 11 Sensitivity controller  
 ○ High  
 ○ Low
- 12 Power cord  
 The suitable one for your area is supplied.
- 13 Adapter  
 Attached to AC125 type only. (This adapter for use in Japan only.)

## 3. Directions for use

### 3.1 Installation

#### Notes

- Do not hold the vibrating platform to carry the unit.  
This may result in deformation or removal of the platform.
- Place the equipment on a flat and stable table.
- Do not put hot items on the main unit.
- When in use near by a radio, interference may occur.
- Do not use near animals. Some react to the ultrasonic wave.
- Avoid high humidity, temperature and direct sunlight.  
These conditions may suddenly start vibration in the AUTO mode.
- Use in a normal lab atmosphere.

### 3.2 Connection

1. Make sure the power switch is OFF (on the back side of the main unit).
2. Connect the power plug to the power cord inlet (on the back side of the main unit).
3. Put the electric plug into the outlet.

#### Notes

This product can be used throughout the world since it can be used between 100V and 240V. However, the voltage range to be used differs depending on the power cord supplied.

AC 125V type cord : 100-120V areas

AC 250V type cord : 220-240V areas

If necessary, use plug adapter to fit the electric outlet (this is not supplied).

### 3.3 Procedure

1. Turn on the POWER switch on the back side of the main unit (I side).
2. Select AUTO or CONT. mode.

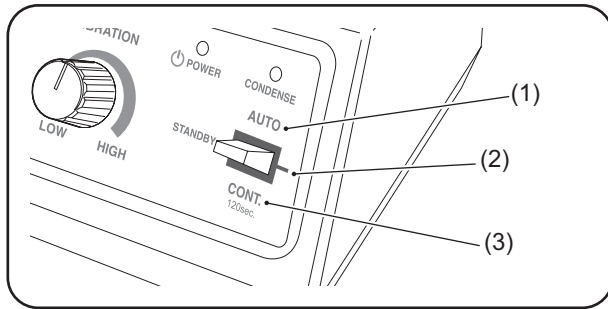

#### 1 AUTO (Automatic Mode)



- Vibration continues for 5 sec. after touching the vibrating platform.
- The switch does not automatically flip back to STANDBY once set at AUTO.
- For safety reason, AUTO mode operation is automatically discontinued after 60 minutes after setting the mode.

#### 2 STANDBY

#### 3 CONT. (Continue Mode)

- Vibration continues for 120 sec. The switch instantly flips back to STANDBY.
- If flipping down to CONT. again, vibration restarts from that point for 120 sec.
- If AUTO is selected, AUTO mode operation starts from that point.

#### Sensitivity controller for AUTO mode

If necessary, adjust the small controller on the back of the main unit using a small screw driver. When turning in the direction of , sensitivity becomes higher. When turning in the direction of , sensitivity becomes lower.

3. Condense by leaning a pair of tweezers against the platform. (Adjust vibration strength by turning the VIBRATION volume.) When turning in the direction of HIGH (right), vibration becomes stronger, while turning in the direction of LOW (left), vibration becomes weaker.
4. Turn off the POWER switch when finished operation.



### Notes

- If turning off and restarting the equipment with the mode set at AUTO, AUTO mode operation can be continued.
- If vibration in AUTO mode can not be performed properly, adjust the sensitivity controller to the point that the platform does not react to the extrinsic vibration or sound.
- If extrinsic vibration or sound affects the operation, set sensitivity control lower or choose CONT. mode.
- AUTO mode operation is automatically discontinued after 60 minutes after setting the mode. Reset to continue the AUTO mode.

- Vibration pattern or strength may differ when in use. Adjust the VIBRATION to obtain desirable performance.
- When discontinuing the operation, set the switch at STANDBY.
- Make sure to switch off especially after operating at AUTO. The machine sound at STANDBY is very soft.
- Do not use continuously when the surface temperature of the vibrating platform becomes over 55°C.
- Vibration pattern and strength slightly differs on each equipment.
- Not all cases can be condensed. Check the condition for each case.

## 4. Display

1. When POWER is ON:  
Yellow/green POWER lamp lights up.
2. While vibrating:  
Orange CONDENSE lamp lights up.
3. When malfunctions:  
Power lamp blinks in yellow/green and red in turn to alarm overheating.

### Note

- When using continuously for a long time, a circuit breaker may work to avoid overheating. When it happens, turn off the POWER switch to cool down the main unit.

## 5. Operation

### OPERATIONAL TIP

#### How to control vibration strength

##### 1 VIBRATION controller

Set basic vibration strength.

##### 2 Contacting strength

Adjust contacting strength against the vibrating platform. When setting the tweezers strongly against the vibrating platform, vibration is transmitted strongly.

##### 3 Contacting position

Vibration strength differs among positions of the vibration platform due to the wave of vibration. Select proper position.

### Condensing Opaque porcelain

1. Build up Opaque porcelain using a brush or spatula and set the tweezers against the vibrating platform intermittently. Remove the moisture leaking up out of the porcelain with a tissue paper.
2. Reapply the Opaque to add the material to the area where the material is decreased due to condensation and then condense again. Repeat this procedure for a couple of times. Then fire with some moisture remaining on the surface.

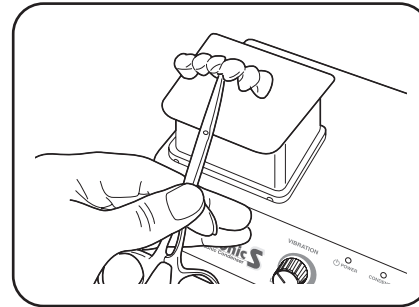

### OPERATIONAL TIP

Use extra caution for bridge work, Opaque material may pour into inter-proximal area by condensation. If any part of Opaque porcelain appears dry, add some water using a brush and then condense.

### **Condensing Body and Enamel porcelain**

1. After building up Body and Enamel porcelain, take the frame out of the model using tweezers. After additional application to the contact points, hold the tweezers handle leaning against the vibrating platform to condense. Exercise extra caution for not ruining the shape since the porcelain contains ample water before condensation. Observe the water gradually coming out from cervical area to the surface and remove with a tissue paper.
2. Repeat this procedure for a few times to add the material to the area where the material is decreased due to condensation and then condense again. Fire the porcelain following the conventional method.

#### **OPERATIONAL TIP**

- When porcelain dries during the operation, add some water and then condense.
- In case of additional porcelain build-up, condense a little to remove some water.
- Condense firmler when making all ceramics crowns than making metal ceramics crowns.

## 6. Maintenance / Check

### How to adjust sensitivity controller

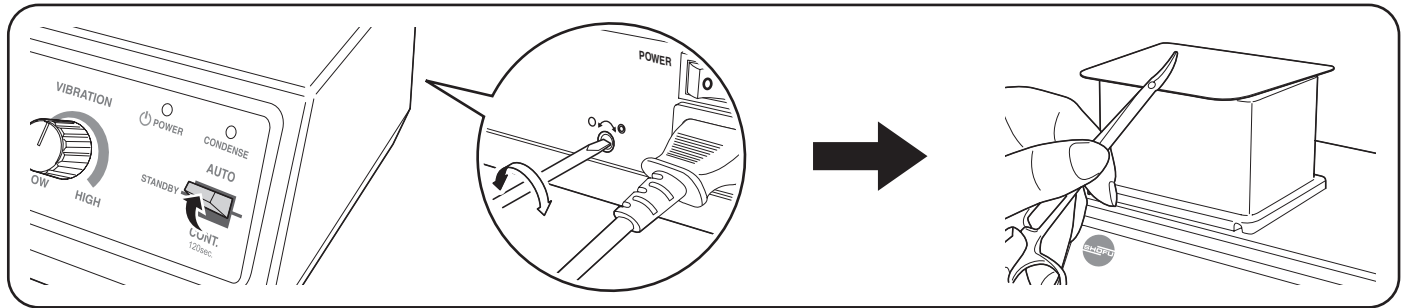

1. Turn the controller slowly from left to right (○ to ⊙) while keeping the mode switch at AUTO.
2. Stop turning at such position that vibration starts.
3. Turn back the controller a little in the direction of ○.
4. Flip down the mode switch to STANDBY, then reset at AUTO.

5. Check the performance by touching the platform with a set of tweezers.
6. Repeat steps 1-4 till desirable sensitivity is obtained.

#### Note

- If the sensitivity controller is adjusted too high, it may operate without touching the platform. In this case, adjust the sensitivity controller at an adequate level not to react external vibration or noise.

## **Maintenance**

Clean using a soft cloth with small amount of mild detergent (polishing agent-free).  
(Do not use dental solvent like MMA or organic solvents such as thinner and acetone etc.)

### **Notes**

- Do not wash or rinse the unit.
- Do not polish the main unit with a cleanser or steel wool sponge. This damages the surface.

## **Others**

### **Notes**

- If vibration does not start, restart the unit.
- Do not insert any metals in the main unit.
- Wear and deformation are expected on the vibrating platform as used for years. This may cause noise and change in vibration strength and pattern.

## **Storage**

Avoid dust for long time storage.

# **7. EU Declaration of Conformity**

Manufacturer: SHOFU Inc.  
Head Office  
11 Kamitakamatsu-Cho, Fukuine, Higashiyama-Ku  
Kyoto 605-0983, Japan

Produkt: "CERAMOSONIC S" condenser

Authorized representative in EU:  
SHOFU Dental GmbH  
Am Brüll 17, D-40878 Ratingen, Germany  
Phone: +49 (0) 2102 / 86 64-0, Fax: +49 (0) 2102 / 86 64-65  
www.shofu.de

The product "CERAMOSONIC S" condenser has been built and tested according to the following relevant EU norms and specifications:

Standard:

- Safety: IEC / EN 61010-1
- EMC: EN61326 : 1997+A1 : 1998+A2 : 2001+A3 : 2003

EC Directive:

- Safety: LVD 2006 / 95 / EC
- EMC: EMC 2004 / 108 / EC

## 8. Troubleshooting

If your condenser seems to be malfunctioning, discontinue use and please check the following points. If none of the solutions below works, ask for inspection and repair by an authorized SHOFU representative.

<b>PROBLEM</b>	<b>SOLUTION</b>
No POWER lamp with the power on	<ul style="list-style-type: none"><li>• Check the power connection.</li><li>• Check power failure.</li></ul>
No vibration	<ul style="list-style-type: none"><li>• Adjust the sensitivity controller at an adequate level.</li><li>• Turn off the switch and restart the equipment.</li></ul>
POWER blinks in yellow/green and red	<ul style="list-style-type: none"><li>• If the temperature of the unit is too high, it will be turned off automatically. Operate the unit after cooling down, again.</li></ul>
Vibration does not stop	<ul style="list-style-type: none"><li>• Adjust the sensitivity controller at an adequate level not to react external vibration or noise.</li><li>• Turn off the switch and restart the equipment.</li></ul>
Vibration level changed	<ul style="list-style-type: none"><li>• Vibration level will change during use. It is not regarded as a problem. Adjust the vibration controller at an adequate level.</li><li>• In case of extraordinarily weak or strong vibration, ask for inspection and repair by an authorized SHOFU representative.</li></ul>
Vibration pattern changed	<ul style="list-style-type: none"><li>• Vibration pattern will change during use. It is not regarded as a problem.</li></ul>
Noise	<ul style="list-style-type: none"><li>• Operating sound will change during use. It is not regarded as a problem.</li><li>• Operating sound slightly differs in each unit.</li><li>• Deformation or excessive impact to the vibrating platform as well as wear and tear due to normal use may cause loud operating sound. It is not regarded as a problem. If it affects the working environment, ask for inspection and repair by an authorized SHOFU representative.</li></ul>

In order to transport the unit for repair, use of original packaging case is recommended.

## 9. Specification

TYPE		SCC-S
Main unit: Supply voltage		AC100-240 V ± 10%, 50/60 Hz
Power cord: (AC 125 type cord)		AC100-110 V ± 10%, 50/60 Hz
Power cord : (AC 250 type cord)		AC220-240 V ± 10%, 50/60 Hz
Power input		20 VA*
Electric consumption		14 W
Output frequency		27,5 kHz ± 10%
Dimensions		160 (W) × 140 (D) × 110 (H) mm
Weight		1,0 kg
Usage condition	Power Capacity	20 W
	Temperature	0 to +40 °C
	Humidity	80% without moisture condensation
Storage condition	Temperature	-5 to +40 °C
	Humidity	80% without moisture condensation

\* This specification is subject to change without prior notice due to product improvement.

## 10. Product configuration

	QUANTITY	NOTE
Main unit	1	–
Power cord	1	–
Adapter	1	AC 125V type only
Instruction manual	1	–
Warranty card	1	–

## 11. Warranty

This product is shipped after strict inspection. Should the product have any problem under normal usage within one year from the date of purchase, repair will be free of charge.

However, the following cases are not covered by the warranty:

- Problem or damage caused by misuse or mishandling
- Problem or damage caused by improper repair or remodeling.
- Problem or damage caused by fire, earthquake, flood and other natural disaster or abnormal voltage.
- Replacement of accessories.
- No indication of purchase date, user name, and dealer name on the warranty card, receipt or invoice from SHOFU Dental or its dealers.
- Deformation or excessive impact to the vibrating platform as well as wear and tear due to normal use may cause loud operating sound, which is not regarded as a problem. Costs of repair will be charged.



**SHOFU INC.** 11 Kamitakamatsu-cho, Fukuine, Higashiyama-ku, Kyoto 605-0983, Japan

**SHOFU INC. Singapore Branch** 10 Science Park Road, #03-12 The Alpha, Science Park II, Singapore 117684

**SHOFU DENTAL TRADING (SHANGHAI) CO., LTD.** No. 645 Jiye Road, Sheshan Industrial Park, Songjiang, Shanghai 201602, China

**SHOFU DENTAL CORPORATION** 1225 Stone Drive, San Marcos, CA 92078-4059, USA

**SHOFU UK** Riverside House, River Lawn Road, Tonbridge, Kent, TN9 1EP, UK

**SHOFU DENTAL GmbH** Am Brüll 17, 40878 Ratingen, Germany ([www.shofu.de](http://www.shofu.de))